

Block Diagram of I-8000

Introduction

The I-8000 is a modular network based system with the capability of connecting I/O either through its own local bus or alternatively through an I/O expansion or network extension. The unit is comprised of a main control unit with a range of standard communication interfaces, and an I/O bus permitting I/O expansion. The bus is hybrid in nature providing the facility to connect either through serial or parallel I/O modules. The parallel bus is used for high-speed data transfer. The unit can communicate either using serial communications (RS232, RS485), Ethernet or CANbus. The Ethernet version of the product supports an integrated web server permitting Internet and Intranet applications. The I-8000 can be used as an intelligent distributed data acquisition front end connected to a host machine running a standard SCADA package, or alternatively it can be user programmed as an autonomous controller running an embedded software application. Significant non-volatile memory is available for data and program storage. The product is made up of four basic components: 1. Main Control Unit (MCU) 2. I/O Expansion Unit 3. I/O modules 4. Embedded OS.

All I-8000 embedded controllers equip MiniOS7 embedded OS. It is developed by ICP DAS Co., LTD and compatible with DOS. MiniOS7 has more features than regular DOS in embedded applications, such as shorter power-up time, built-in hardware diagnostic function, direct support for I-8000 and I-7000 modules, and direct support for internal memory devices.

i-8000 Compact PAC SERIES

Solution for Internet/Intranet

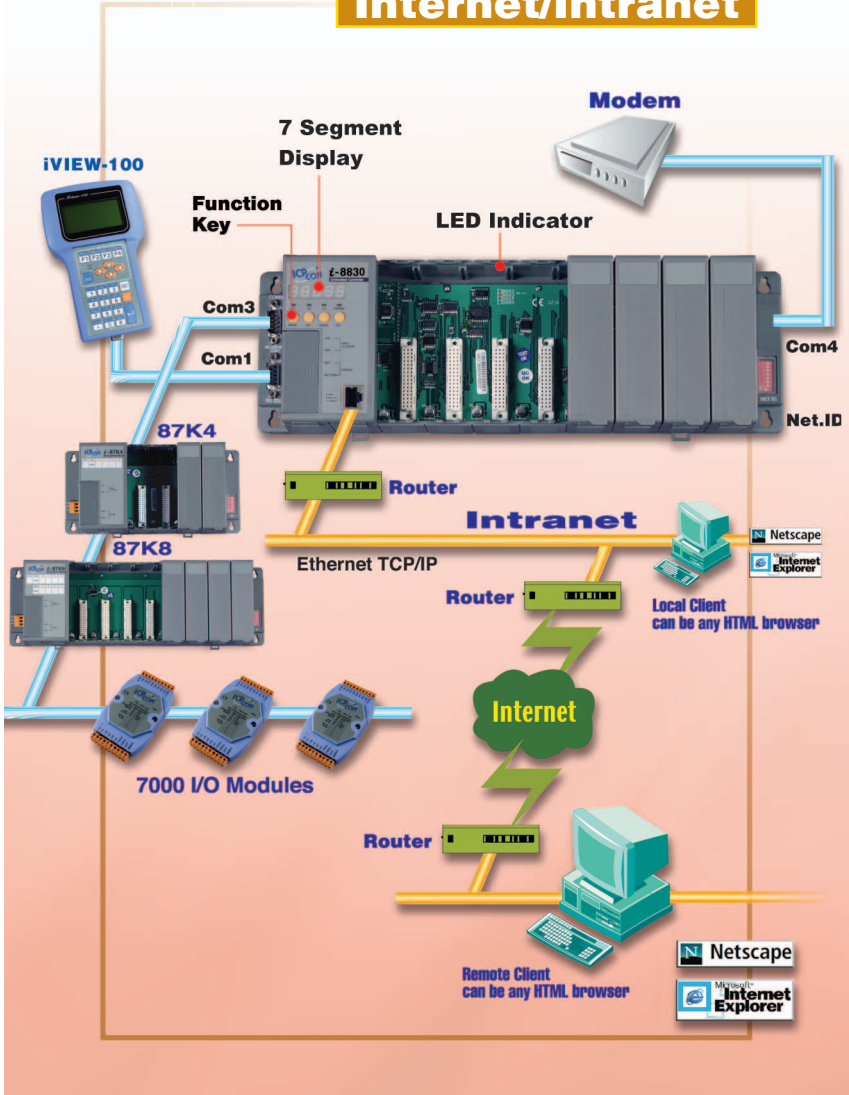

i-8000 Compact PAC SERIES

Connecting I-841X/881X to Host-PC

Configuration A

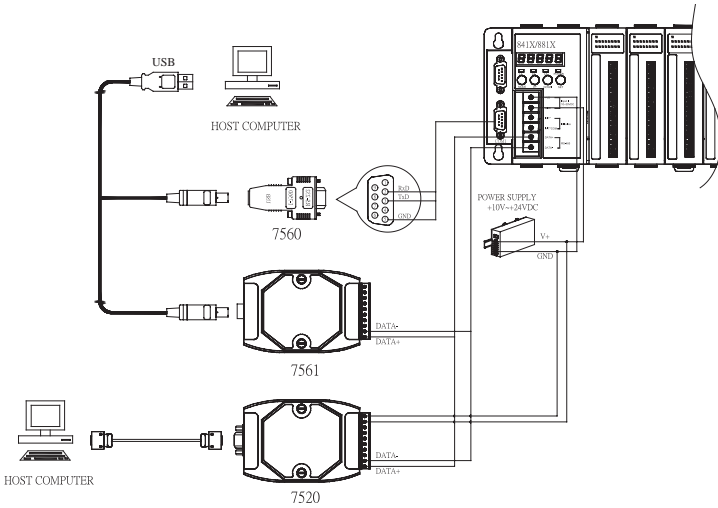

Configuration B

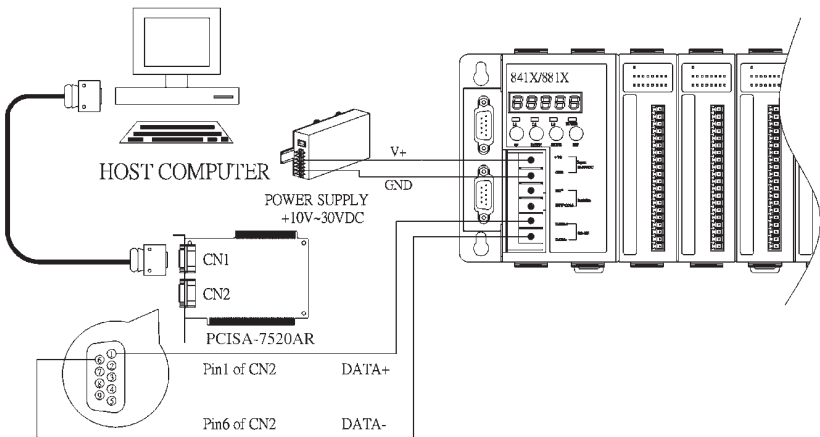

i-8000 Compact PAC SERIES

Configuration C

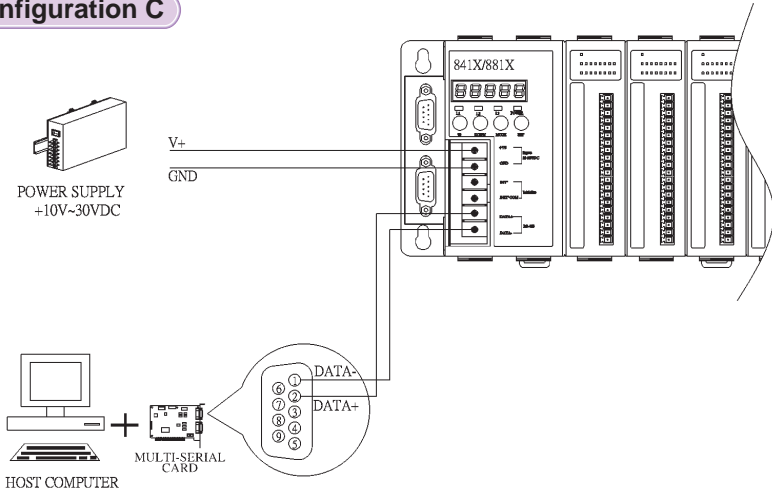

Configuration D

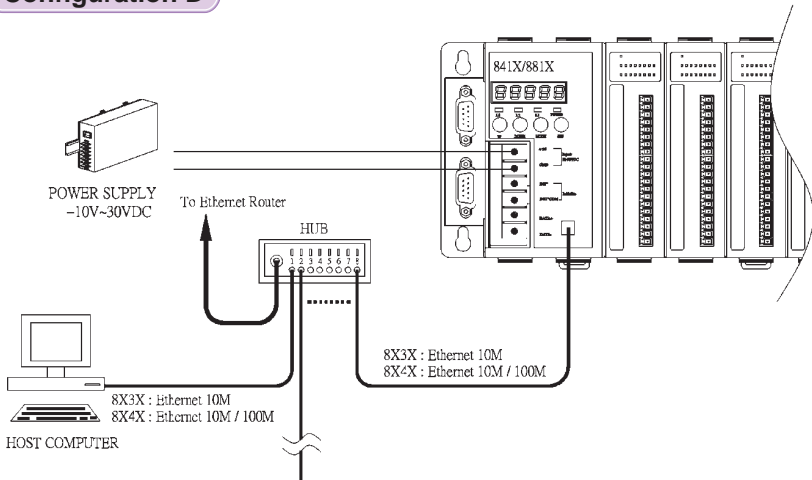

i-8000 Main Control Unit (MCU)

SERIES

1. Main Control Unit (MCU):

The MCU is the powerhouse of the I-8000. Each MCU is comprised of a central processor module (CPM), a power supply, and a four (4) or eight (8) slot backplane for either 4 or 8 Parallel I/O modules. The CPM is a powerfully integrated processing engine consisting of a CPU, RAM, ROM, and an option of communication interfaces including RS-485, Ethernet and CANbus.

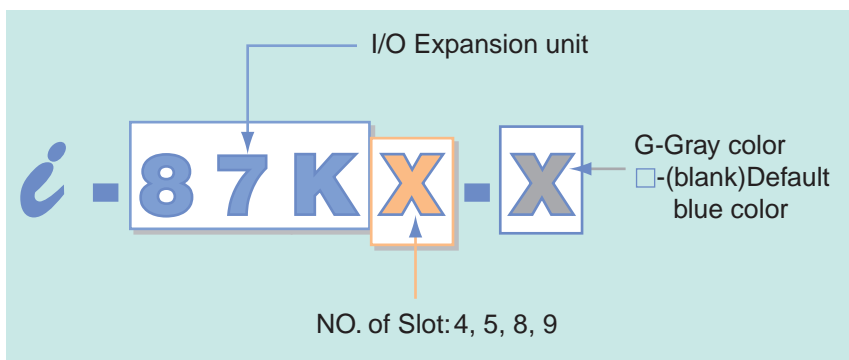
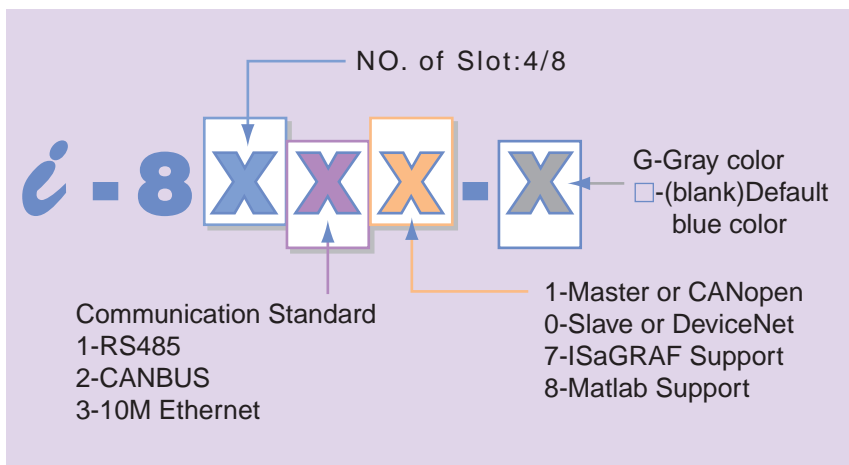

i-8000 Main Control Unit (MCU)

SERIES

Main Control Unit Selection Guide

Model	Description (Note1)	CPU 80188 40MHz	Flash	SRAM	Slot	COM1 Note2	COM2	COM3 Note4	COM4 Note5
I-8410 I-8810	PAC	Y Note 6	256KB	256KB	4 8	Y	RS-485 NOTE3	Y	-
I-8411 I-8811	PAC	Y Note 6	512KB	512KB	4 8	Y	RS-485 NOTE3	Y	Y
I-8417 I-8817	ISaGRAF PAC	Y Note 6	512KB	512KB	4 8	Y	RS-485 NOTE3	Y	Y
I-8418 I-8818	Matlab PAC	80186 80MHz	512KB	512KB	4 8	Y	RS-485 NOTE3	Y	Y
I-8420 I-8820	PAC	80186 80MHz	512KB	512KB	4 8	Y	CAN DeviceNet	Y	-
I-8421 I-8821	PAC	80186 80MHz	512KB	512KB	4 8	Y	CAN open	Y	Y
I-8430 I-8830	PAC	Y Note 6	512KB	256KB	4 8	Y	10 Base T	Y	-
I-8431 I-8831	PAC	Y Note 6	512KB	512KB	4 8	Y	10 Base T	Y	Y
I-8437 I-8837	ISaGRAF PAC	Y Note 6	512KB	512KB	4 8	Y	10 Base T	Y	Y
I-8438 I-8838	Matlab PAC	80186 80MHz	512KB	512KB	4 8	Y	10 Base T	Y	Y

Note1: All of the above PAC are equipped with MiniOS7 and Self-tuner chip.

Note2: RS-232 port; 115.2K bps; TXD, RXD signal; Program download port.

Note3: Isolated RS-485 port; 115.2K bps; Data+, Data-

Note4: RS-232/RS-485; 115.2K bps; RS-232/TXD, RXD, RTS, CTS, GND; RS-485/Data+, Data-

Note5: RS-232 port; 115.2K bps; RS-232/TXD, RXD, RTS, CTS, DSR, DTR, DCD, RI, GND; Modem control

Note6: CPU can be upgraded to 80186,80MHz.

Optional:

The X-socket of Main control unit can be installed with an SRAM module. There are two options as follows:

1. S256: 256K battery backup SRAM module for all I-8000 PAC
2. S512: 512K battery backup SRAM module for all I-8000 PAC

i-8000 Compact PAC

SERIES

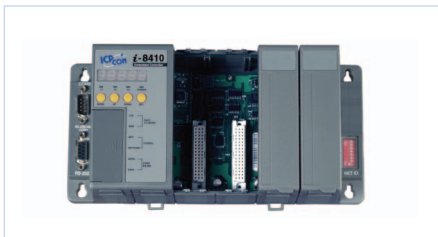

Ordering Information:

I-8410: PAC

I-8410-G: I-8410 with Gary color

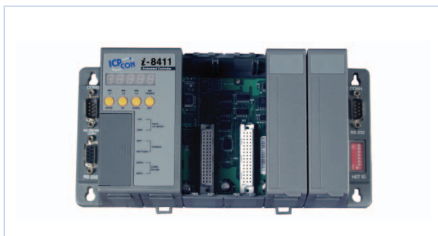

Ordering Information:

I-8411: PAC

I-8411-G: I-8411 with Gary color



Ordering Information:

I-8810: PAC

I-8810-G: I-8810 with Gary color

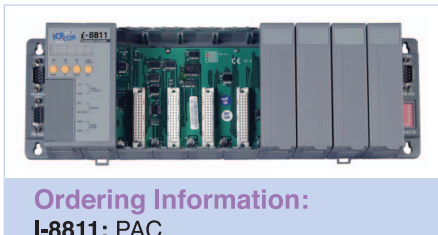

Ordering Information:

I-8811: PAC

I-8811-G: I-8811 with Gary color

Specifications & Features

- CPU 80188, 40MHz
- SRAM:
 - 256K bytes (for I-8410/8810)
 - 512K bytes (for I-8411/8811)
- Flash Memory:
 - 256K bytes (for I-8410/8810)
 - 512K bytes (for I-8411/8811)
- EEPROM: 2K bytes
- 64-bit hardware unique serial number (for I-8411/8811)
- Built-in Watchdog Timer
- Real Time Clock (for I-8411/8811)
- COM0: Internal use
- COM1: RS-232/Program download port
- COM2: RS-485
- COM3: RS-232/485
- COM4: RS-232 (I-8411/8811)
- S-MMI:
 - Small Man Machine Interface
- I/O Expansion Slot
 - 4-slot for I-8410/8411
 - 8-slot for I-8810/8811
- Power Supply: 20W Unregulated +10Vdc to +30Vdc
- Power Consumption:
 - I-8410/I-8411: 3.9W
 - I-8810/I-8811: 5.1W
- Environment
 - Operating Temp.: -25°C to + 75°C
 - Storage Temp.: -30°C to + 85°C
- Humidity: 5 ~95%
- Dimensions:
 - 354 x 110 x 75.5 mm (8-slot)
 - 230 x 110 x 75.5 mm (4-slot)

i-8000 Compact PAC

SERIES

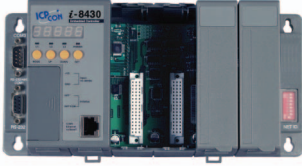

Ordering Information:

I-8430: PAC

I-8430-G: I-8430 with Gray color

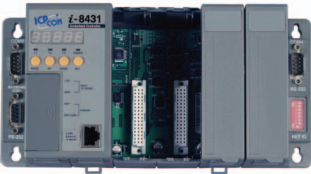

Ordering Information:

I-8431: PAC

I-8431-G: I-8431 with Gray color

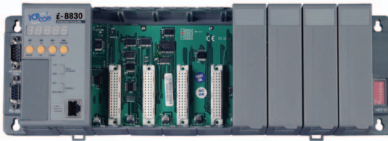

Ordering Information:

I-8830: PAC

I-8830-G: I-8830 with Gray color

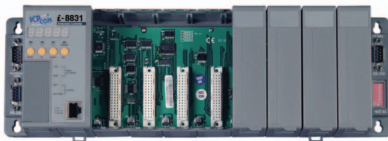

Ordering Information:

I-8831: PAC

I-8831-G: I-8831 with Gray color

Specifications & Features

- CPU 80188, 40MHz
- SRAM:
 - 256K bytes (for I-8430/8830)
 - 512K bytes (for I-8431/8831)
- Flash Memory: 512K bytes
- EEPROM: 2K bytes
- 64-bit hardware unique serial number (for I-8431/8831)
- Built-in Watchdog Timer
- Real Time Clock (for I-8431/8831)
- COM0: Internal use
- COM1: RS-232/Program download port
- 10 Base T: NE2000 compatible
- COM3: RS-232/485
- COM4: RS-232 (I-8431/8831)
- S-MMI:
 - Small Man Machine Interface
- I/O Expansion Slot
 - 4-slot for I-8430/8431
 - 8-slot for I-8830/8831
- Power Supply: 20W
 - Unregulated +10Vdc to +30Vdc
- Power Consumption:
 - I-8430/I-8431: 3.9W
 - I-8830/I-8831: 5.1W
- Environment
 - Operating Temp.: -25°C to + 75°C
 - Storage Temp.: -30°C to + 85°C
- Humidity: 5 ~95%
- Dimensions:
 - 354 x 110 x 75.5 mm (8-slot)
 - 230 x 110 x 75.5 mm (4-slot)
- **Support VxComm technique & Xserver**

What is Modbus

What is Modbus protocol ?

Modbus is a communication protocol developed by MODICON Inc. in 1979. It's a standard, truly opened and the most widely used network communication protocol in industrial automation field. SCADA and HMI software can easily integrate serial devices together via Modbus protocol.

What is Modbus/TCP protocol ?

Modbus/TCP protocol is a variant of Modbus protocol. It was developed in 1999 to allow Internet community access Ethernet devices.

What software supports Modbus and Modbus/TCP protocol?

Citect, ICONICS, iFIX, InduSoft, Intouch, Entivity Studio, Entivity Live, Entivity VLC, Wizcon, Trace Mode and Wonderware ... etc

What are the benefits of using Modbus and Modbus/TCP protocol ?

1. Openness, no license fees.
2. Widely supported by SCADA and HMI software
3. Easy to use
4. Easily integrate different devices
5. Low development cost
6. Widely knowledge resource

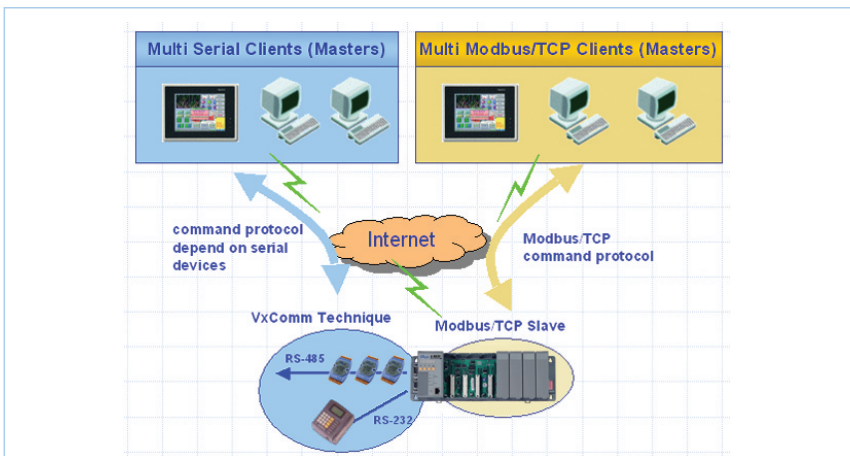

Default firmware features

- Supports Modbus/TCP communication protocol to access I/Os that plugged in slots.
- Supports VxComm technique for every COM port of controllers.
- Supports 8K and 87K DI/DO/AI/AO modules.
Please refer detail list in Modbus Utility on-line help.
- Automatically scan I/O modules.
You can plug I/O modules in any slot. Don't mind the slot order, it doesn't matter
- Allowed a maximum of 8 host PCs access simultaneously.
In fact, it can allow 16 host PCs access simultaneously.
But for getting better stability, we recommend you don't use more than 8 host PCs to access a Modbus/TCP controller.
- Firmware updateable

Modbus SDK (in C language)

We provide Modbus SDK to users. You can use it to integrate several serial devices. Thus the controller can be a Modbus/TCP slave and Modbus/RTU master. The Modbus SDK has below features:

- Supports extra user-defined command protocol
- Register based programming method (easy to use)
- Can link Modbus/RTU slave devices
- Supports user-defined registers
- Can link to non-standard serial devices
- Xserver SDK compatible

Hardware specifications

Same as I-8430, I-8431, I-8830, I-8831

Ordering Information

- **I-8430 -MTCP:** Modbus/TCP PAC with 4 slots
- **I-8431 -MTCP:** Modbus/TCP PAC with 4 slots
- **I-8830 -MTCP:** Modbus/TCP PAC with 8 slots
- **I-8831 -MTCP:** Modbus/TCP PAC with 8 slots

i-8KE4 / i-8KE8 Ethernet Expansion Unit

Features

- Supports DCON communication protocol to access I/Os that plugged in slots.
- Supports VxComm technique for every COM port of controllers.
- Supports 8K and 87K DI/DO/AI/AO modules.
- Automatically scan I/O modules.
You can plug I/O modules in any slot. Don't mind the slot order, it's doesn't mater
- Allowed a maximum of 8 host PCs access simultaneously.
In fact, it can allow 16 host PCs access simultaneously.
But for getting better stability, we recommend you don't use more than 8 host PCs to access a single controller.

Hardware specifications

- CPU: 80186, 80M Hz
- SRAM: 512K (16 bits)
- FLASH: 512K
- EPROM: 2K
- Com 0: Internal use
- Com 1: RS-232
- 10BaseT: NE 2000 compatible
- I/O Expansion Slot
4-slot for 8KE4
8-slot for 8KE8
- Power Supply: 20W
Unregulated +10Vdc to +30Vdc
- Environment
- Operation Temp.: -25°C to +75°C
Storage Temp.: -30°C to +85°C
Humidity: 5 ~ 95 %
- Dimensions:
354 x 110 x 75.5 mm (8-slot)
230 x 110 x 75.5 mm (4-slot)

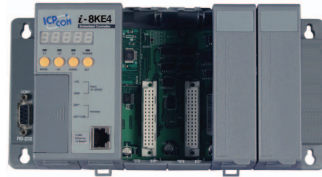

Ordering Information:

- I-8KE4:** 4 Expansion Slot Ethernet I/O
- I-8KE4-G:** I-8KE4 with Gray color

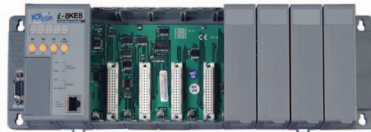

Ordering Information:

- I-8KE8:** 8 Expansion Slot Ethernet I/O
- I-8KE8-G:** I-8KE8 with Gray color

Why CANopen ?

CANopen, a kind of network protocols, is based on the intelligent field bus (CAN bus). It was developed as a standardized network system with highly flexibility, and provides several standardized communication objects for real-time data, configuration data, network management data, and so forth. The CANopen network management services simplify project design, system integration, and diagnostics. By now, CANopen is used in many various application fields, such as medical equipment, off-road vehicles, maritime electronics, public transportation, building automation and etc. Please refer to the web site <http://www.can-cia.org> for more information.

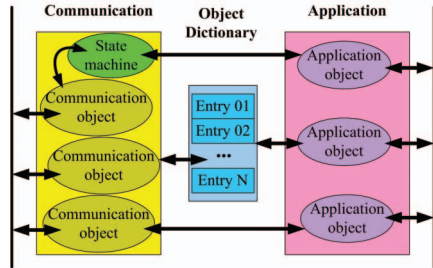

CANopen, a kind of network protocols, is based on the intelligent field bus (CAN bus). It was developed as a standardized network system with highly flexibility, and provides several standardized communication objects for real-time data, configuration data, network management data, and so forth. The CANopen network management services simplify project design, system integration, and diagnostics. By now, CANopen is used in many various application fields, such as medical equipment, off-road vehicles, maritime electronics, public transportation, building automation and etc. Please refer to the web site <http://www.can-cia.org> for more information.

CANopen Remote I/O modules

I-8KCPS1/I-8KCPS2/I-8421 are specially designed for the slave device of CANopen protocols. They can support up to 4 expansion slots to expand their I/O channel numbers. Users can choose either the I-87K or the I-8000 series DI/DO/AI/AO slot modules to fit their customized practice applications. In addition, we also provide the CAN Slave Utility to create EDS files dynamically. This EDS file is helpful to apply these module in different CANopen master.

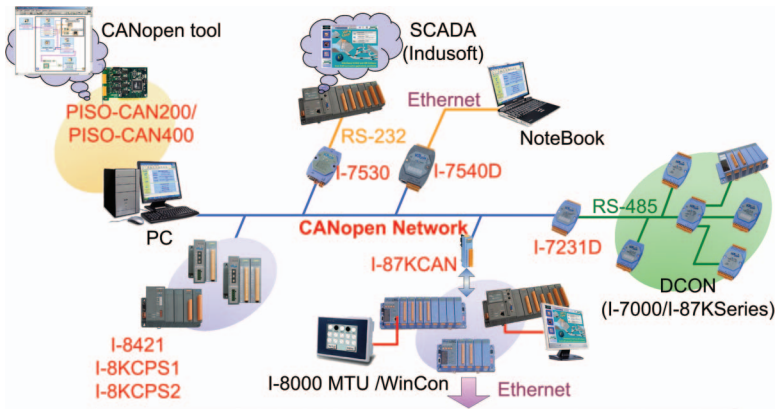
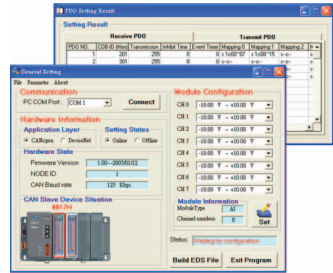

**Ordering Information:**

I-8KCPS1-G: CANopen PAC with
1 expansion I/O slot

**Ordering Information:**

I-8KCPS2-G: CANopen PAC with
2 expansion I/O slots

**Ordering Information:**

I-8421-G: CANopen PAC with
4 expansion I/O slots

Hardware Features

- CPU:80186, 80MHz
- SRAM:512K bytes
- Flash Memory:512K bytes
- EEPROM:2k bytes
- NVRAM: 32 bytes
- Built-in Watchdog Timer
- Real Time Clock
- 16-bit Timer
- COM1:RS-232 (Utility communication port only for I-8421-G)
- CAN bus interface: ISO/IS 11898-2, 5-pin screw terminal with on-board optical isolators protection.
- Philip SJA1000 CAN controller
- Philip 82C250 CAN transceiver
- 2500 Vrms isolation on CAN side
- 120Ω terminal resistor selected by jumper
- Board Rate up to 1Mbps
- Power LED, RUN LED, and ERR LED
- Support 1/2/4 expansion I/O slots
- Power Supply:20W, Unregulated +10VDC to +30VDC
- Operating Temperature:-25°C to +75°C
- Storage Temperature:-30°C to +85°C
- Humidity:5%~95%
- Dimensions:
63x110x75.5 mm (I-8KCPS1)
115x110x75.5 mm (I-8KCPS2)
230x110x75.5 mm (I-8421)

Firmware Specifications

- NMT: Slave
- Error Control: Node Guarding
- Node ID: Setting by Rotary Switch
- No. of PDOs: 16 Rx, 16Tx
- PDO Modes: Event-triggered, remotely requested, cyclic and acyclic SYNC
- PDO Mapping: variable
- No of SDOs: 1 server, 0 client
- Emergency Message: Yes
- ID: Hardware rotary switch
- Baud: Hardware rotary switch
- Baud Rate support: 10K, 20K, 50K, 125K,250K, 500K, 800K, and 1Mbps
- CANopen Version: DS-301 v4.01
- Device Profile: DSP-401 v2.0
- Support both CAN 2.0A / 2.0B

Why DeviceNet?

DeviceNet is one kind of the network protocols based on the CAN bus and mainly used in industrial automation, such as injection molding machinery, textile machinery, printing or packaging machines, etc. It is a low level network that provides connections between simple industrial sensors/actuators and higher level devices. There are some DeviceNet features shown below.

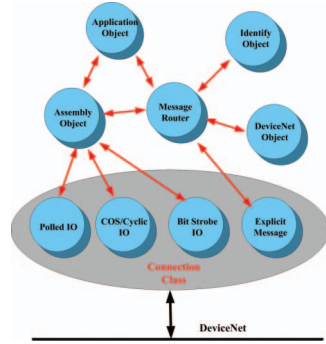

- Multi-vendor interoperability
- Fast, easy installation - resulting in space and time savings
- Future-ready, for easy additions as your needs expand and change
- Improved uptime through intelligent insight into device operations
- Efficient bandwidth utilization through producer/consumer communications
- On-the-fly configuration/re-configuration and additions without powering down

DeviceNet Remote I/O Modules

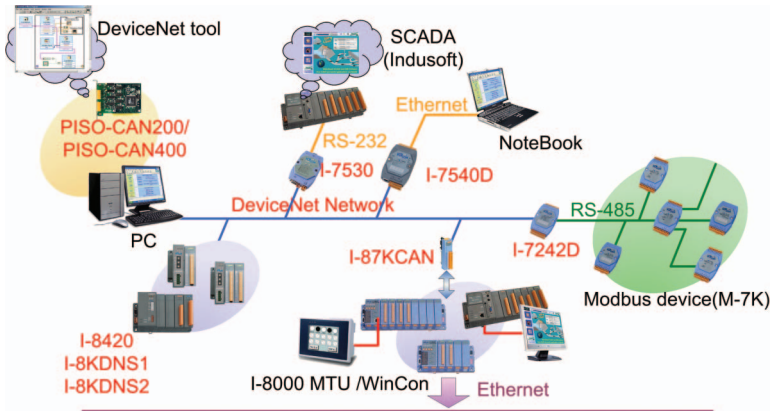

I-8KDNS1, I-8KDNS2 and I-8x20 are the small/middle size DeviceNet slave devices. These devices offer a flexible I/O selection and useful utility tool to build a variety DeviceNet application. They not only support most of ICPDAS I/O modules but also provide up to 4 expansion slots to expand the I/O channels. By using the other ICPDAS DeviceNet devices integrations, users can easily build their DeviceNet network for their different application.

**Ordering Information:**

I-8KDNS1-G: DeviceNet PAC with
1 expansion I/O slot

**Ordering Information:**

I-8KDNS2-G: DeviceNet PAC with
2 expansion I/O slots

**Ordering Information:**

I-8420-G: DeviceNet PAC with
4 expansion I/O slots

Hardware Features

- CPU:80186, 80MHz
- SRAM:512K bytes
- Flash Memory:512K bytes
- EEPROM:2k bytes
- NVRAM: 32 bytes
- Built-in Watchdog Timer
- Real Time Clock
- 16-bit Timer
- COM1:RS-232 (Utility communication port only for I-8421-G)
- CAN bus interface: ISO/IS 11898-2, 5-pin screw terminal with on-board optical isolators protection.
- Philip SJA1000 CAN controller
- Philip 82C250 CAN transceiver
- 2500 Vrms isolation on CAN side
- 120Ω terminal resistor selected by jumper
- Support 1/2/4 expansion I/O slots
- Power Supply:20W, Unregulated +10VDC to +30VDC
- Operating Temperature:-25°C to +75°C
- Storage Temperature:-30°C to +85°C
- Humidity:5%~95%
- Dimensions:
63x110x75.5 mm (I-8KDNS1)
115x110x75.5 mm (I-8KDNS2)
230x110x75.5 mm (I-8420)

Firmware Specifications

- DeviceNet Version: DeviceNet Specification Volume I & II, Release 2.0
- Number of Nodes: 64(Max)
- Baud Rate: 125K, 250K, 500K
- Support Message Groups: Group 2 only Server
- UCMM: Not Support
- I/O Operating Modes: Poll, Bit-Strobe, Change of State/ Cyclic
- Device Heartbeat Message: Yes
- Device Shutdown Message: Yes
- Produce EDS file Dynamically: Yes
- No. of Fragment I/O: 128 Bytes (Max) (Input/ Output)
- MAC ID Setting: Rotary Switch
- Baud Rate Setting: Rotary Switch
- DeviceNet Status LED: NET, MOD, PWR

i-8000 **ISaGRAF Embedded Controller**

SERIES

What is ISaGRAF ?

ISaGRAF is a PLC-like software running on Windows 95/ 98/ NT/ 2000/ XP. It supports all five IEC61131-3 languages, Ladder Diagram (LD), Structured Text (ST), Function Block Diagram (FBD), Sequential Function Chart (SFC), and Instruction List (IL). More information at <http://www.icpdas.com/products/PAC/i-8000/isagraf.htm>

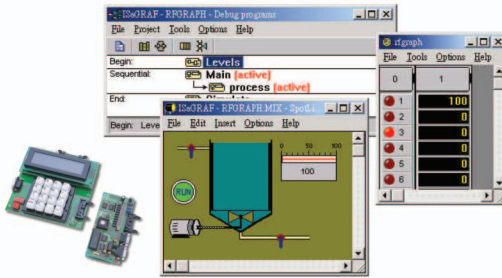

ISaGRAF PAC

ICP DAS provides many controller types supporting ISaGRAF. They are I-8417/8817/8437/8837, I-7188EG/XG and W-8x37/8x47 & W-8x36/x846. They can be easily integrated with many HMI softwares and devices such as Indusoft, iFix, Iconics, Wizcon, Intouch, Citect, Modbus OPC server, ICP DAS's MMICON, Touch 506T, 506L & 510T, etc.

Features:

1. All five IEC61131-3 languages, LD, ST, FBD, SFC and IL, plus Flow Chart.
2. Modbus RTU protocol (RS-232/485) to integrate to SCADA softwares and HMI.
3. Modbus TCP/IP to integrate to SCADA softwares and HMI. (i-8437/8837, I-7188EG & W-8x37/8x47 & W-8x36/8x46)
4. Controller to Controller Data Exchange via RS485.
5. Controller to Controller Data Exchange via Ethernet. (I-8437/8837, I-7188EG & W-8x37/8x47 & W-8x36/8x46)
6. Remotely download and monitor the program via a modem.
7. Modbus Master protocol to link to other devices which support Modbus RTU protocol.
8. All I-7000 & I-87K series I/O modules can be integrated as remote I/O modules.
9. W-8x37/8x47 & W-8x36/8x46 support Web HMI that allow other PCs to browse it via Internet Explorer.
10. Spotlight-A Simple HMI included in ISaGRAF to make application more friendly.
11. Auto-scan I/O: Automatically scan I/O boards & declare I/O variables.
12. Data log: data, date & time can be stored at S256/S512 for I-8xx7, while X607/X608 for I-7188EG/XG, and then PC can load these data via RS232/RS485, ethernet & Modem.
13. SMS: When integrating with a GSM Modem, Short Message Service is available.
14. Motion: Motion control is available when i-8091 boards integrated.
15. Wincon-8047/8347/8747 supports "Controller Redundancy" feature.
16. ISaGRAF version 3 supports "Variable Array". More at <http://www.icpdas.com/faq/isagraf.htm>

Ordering Information:

ISaGRAF-256-E: ISaGRAF Ver. 3 Software, 256 I/O Tags + one English book

ISaGRAF-256-C: ISaGRAF Ver. 3 Software, 256 I/O Tags + one Chinese book



Ordering Information:

I-8417: ISaGRAF PAC

I-8417-G: I-8417 with Gray color



Ordering Information:

I-8437: ISaGRAF PAC

I-8437-G: I-8437 with Gray color

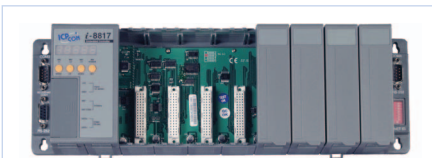

Ordering Information:

I-8817: ISaGRAF PAC

I-8817-G: I-8817 with Gray color



Ordering Information:

I-8837: ISaGRAF PAC

I-8837-G: I-8837 with Gray color

Specifications & Features

- The hardware of I-8417 is the same as I-8411. The I-8000 Target driver and ISaGRAF Target license are included
- The hardware of I-8437 is the same as I-8431. The I-8000 Target driver and ISaGRAF Target license are included
- The hardware of I-8817 is the same as I-8811. The I-8000 Target driver and ISaGRAF Target license are included
- The hardware of I-8837 is the same as I-8831. The I-8000 Target driver and ISaGRAF Target license are included

I-8438/8838 is the ICP DAS MATLAB PAC solution built in Ethernet and series interface with I/O expansion slots for Matlab development environment. For this application there are over 20 I/O bridges and system-level Simulink Blocksets have been developed. By using Simulink development environment and these Matlab Driver's blocksets, control algorithm can be easily constructed and verified without writing any code. Once the algorithm has been verified, by pressing a "build" button, users can convert a model to executable code, and download it to I-8438/8838 PAC for test or practical application by RS232 and Ethernet. Furthermore, engineers can put more focus on advanced control algorithm design and development.

Software required :

1. Matlab v6.1 or v6.5
2. Simulink v4.1 or v5.0
3. Real-Time Workshop v4.1 or v5.0
4. Real-Time Workshop embedded coder v2.0 or v3.0
5. ICPDAS Matlab PAC Development Kits

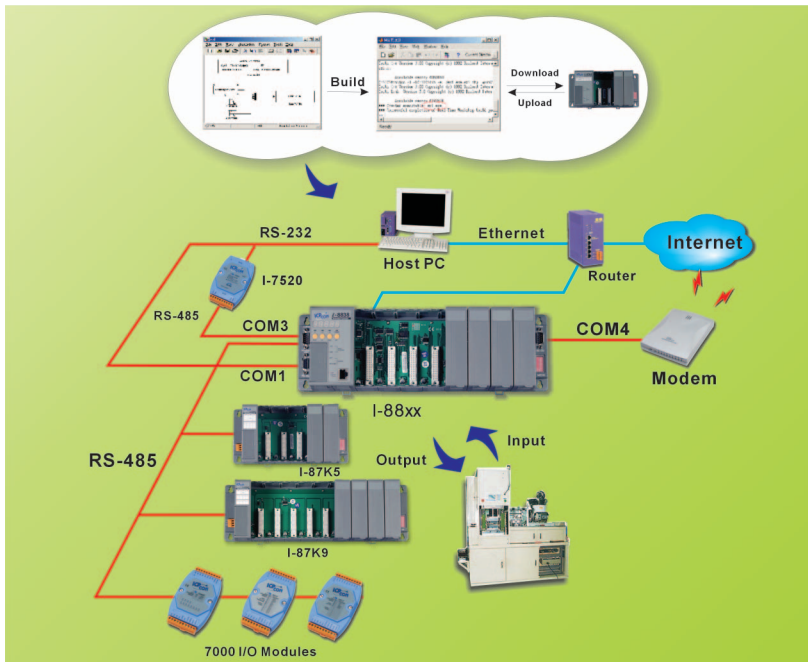



Ordering Information:
I-8438-G: Matlab PAC

COMMON Specifications

- CPU:80186,80MHz

Specifications & Features

- Except CPU, the hardware of I-8438 is the same as I-8431. The IO bridge for I-8000 is included

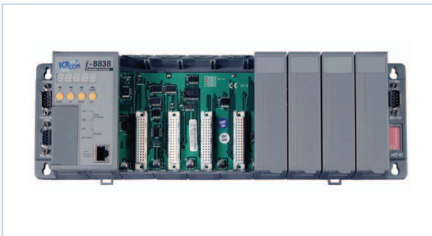

Ordering Information:
I-8838-G: Matlab PAC

- Except CPU, the hardware of I-8838 is the same as I-8831. The IO bridge for I-8000 is included

i-87K I/O Expansion Unit

SERIES

2. I/O Expansion Unit:

The I/O expansion units are used to extend the number of I/O modules. Each expansion unit consists of a Power supply and a Back Plane with 4, or 5 or 8 or 9 Serial I/O Expansion Slots. The I/O expansion units, 87K4, 87K5, 87K8, 87K9 are equipped with a 115.2K bps RS-485 bus which links the expansion unit to the main control unit.

Block Diagram of 87K Expansion unit

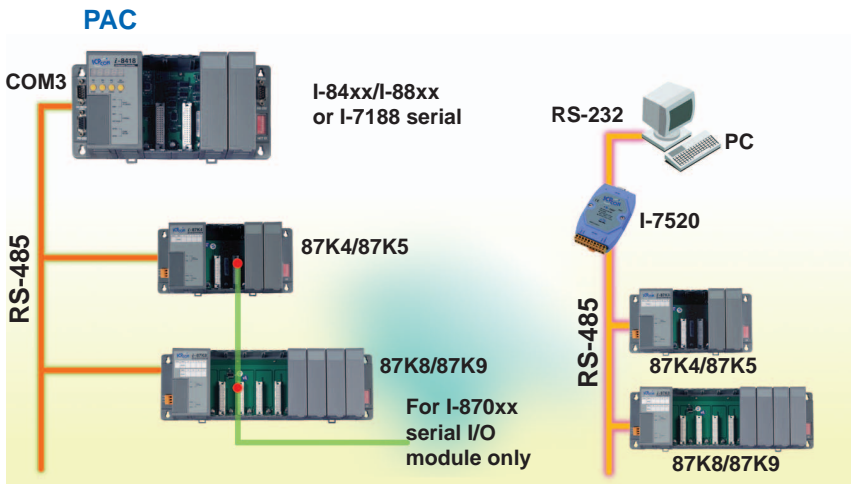

I/O Expansion Unit Selection Guide

Model	Description	CPU	Slot	Power Supply	COM Port	I/O Module Supported
87K4 I/O Expansion Unit	4 Slot I/O Expansion Unit	None	4	20W	(Note1)	Serial I/O Module only
87K5 I/O Expansion Unit	5 Slot I/O Expansion Unit	None	5	20W	(Note1)	Serial I/O Module only
87K8 I/O Expansion Unit	8 Slot I/O Expansion Unit	None	8	20W	(Note1)	Serial I/O Module only
87K9 I/O Expansion Unit	9 Slot I/O Expansion Unit	None	9	20W	(Note1)	Serial I/O Module only

Note1: Isolated RS-485 port; 115.2K bps; Data+, Data-

i-87K I/O Expansion Unit

SERIES



Ordering Information:

I-87K4: I/O Expansion unit with 4 I/O slots
I-87K4-G: I-87K4 with Gray color



Ordering Information:

I-87K5: I/O Expansion unit with 5 I/O slots
I-87K5-G: I-87K5 with Gray color

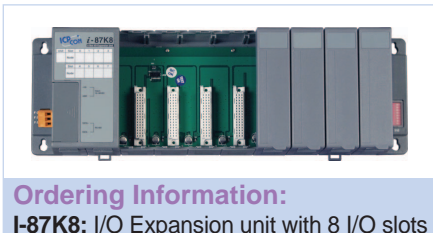

Ordering Information:

I-87K8: I/O Expansion unit with 8 I/O slots
I-87K8-G: I-87K8 with Gray color

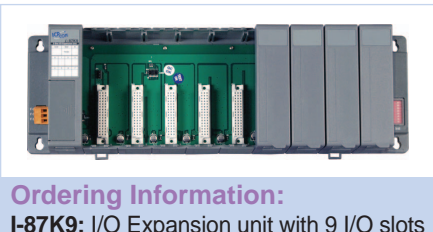

Ordering Information:

I-87K9: I/O Expansion unit with 9 I/O slots
I-87K9-G: I-87K9 with Gray color

Specifications & Features

COM Port

- RS-485, 115.2K bps max.
- Data+, Data-
- Max. distance:
4000 feet (1.2Km)
- Isolation voltage: 3000Vdc

I/O Expansion Slot

- Support serial I/O
- 4 slots for I-87K4, 5 slots for I-87K5, 8 slots for I-87K8, 9 slots for I-87K9

Power Supply

- Unregulated +10Vdc to +30Vdc
- 20W

Environment

- Operating Temperature:
-25°C to + 75°C
- Storage Temperature:
-30°C to + 85°C
- Humidity:
5 ~ 95%, non-condensing

i-8000 I/O Modules

SERIES

3. I/O Modules

There are two types of I/O modules, Parallel and Serial. The parallel modules are high-speed modules and have to be installed in the Main Control Unit. The Serial I/O Modules can be installed in either the Parallel or Serial I/O expansion slots.



Parallel I/O Modules (8K series Modules)

Features:

- High speed A/D: 100K samples/second
- High speed D/A: 30K from -10V to +10V
- High speed D/I & D/O; All Digital I/O Modules provide visual indication of status via LED indicators.
- High speed stepping/Servo motion control module
- High speed encoder module
- High performance Counter / Frequency modules
- High speed multi-channel RS-232/RS-422/RS-485 modules
- Printer interface & X-Socket interface module

Serial I/O modules (87K series Modules)

Features:

- RTD Sensor Input Module
- Thermocouple Input Module
- Strain Gauge Input Module
- High Resolution Multi-channel Analog Input Module
- Isolated Multi-channel D/A Modules
- Digital Input and Digital Output Modules with Latch and Counter Function
- Counter / Frequency Modules

i-8000 Parallel I/O Modules

SERIES

i-8000

8K Digital I/O Module Selection Guide

Model	I-8037	I-8040	I-8041	I-8042	I-8048	I-8050	I-8051
Digital input Channels	—	32	—	16	8 with Interrupt	Can be up to 16	16
Digital Output Channels	16 open source isolation 3750V	—	32	16	—	Can be up to 16	—
LED Display	Yes	Yes	Yes	Yes	Yes	Yes	Yes
Safe Value	Yes	—	Yes	Yes	—	—	—
Power-on Preset Value	Yes	—	Yes	Yes	—	—	—
Dual Watchdog	—	—	—	—	—	—	—
Availability	Yes	Yes	Yes	Yes	Yes	Yes	Yes

Model	I-8052	I-8053	I-8054	I-8055	I-8056	I-8057	I-8058
Digital input Channels	8 isolation 5000V differential	16 isolation 3750V	8 isolation 3750V	8	—	—	8 isolation 3750V AC/DC Max.250V Input
Digital Output Channels	—	—	8 open collector isolation 3750V	8 open collector	16 open collector	16 open-collector isolation 3750V	—
LED Display	Yes	Yes	Yes	Yes	Yes	Yes	Yes
Safe Value	—	—	Yes	Yes	Yes	Yes	—
Power-on Preset Value	—	—	Yes	Yes	Yes	Yes	—
Dual Watchdog	—	—	—	—	—	—	—
Availability	Yes	Yes	Yes	Yes	Yes	Yes	Yes

8K Digital Modules

I-8037



I-8037-G



I-8037 / I-8037-G (Gray color)

16-channel Isolated Open-source Output Module

- Digital output channels : 16
- Digital output : Open-source
- Digital output : Output 100mA / 30V(Max)
- Isolation: 3750 Vrms
- Power consumption: 0.5W

I-8040



I-8040-G



I-8040 / I-8040-G (Gray color)

32-channel Isolated Digital Input Module

- Digital input channels: 32
- 3750V isolation (External power)
- 3000V isolation (Internal power)
- Input Voltage: 3.5V~30V
- Power consumption: 0.3W

I-8041



I-8041-G



I-8041 / I-8041-G (Gray color)

32-channel Isolated Digital Output Module

- Digital output channels: 32
- 3750V isolation (External power)
- Open-collector Output: 125mA/channel
- Power consumption: 1.7W

I-8042



I-8042-G



I-8042 / I-8042-G (Gray color)

16-channel Isolated Digital Input & 16-channel Isolated Digital Output Module

- Digital Input channels: 16
- Digital Output channels: 16
- Other spec. are similar to I-8040 and I-8041
- Power consumption: 1.5W

8K Digital Modules

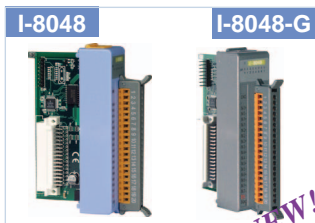

I-8048 / I-8048-G (Gray color)

8-channel Digital Input with Interrupt Module

- Parallel I/O Module
- Digital Input Channels: 8
- Input Signal: isolated or non-isolated by Jumper
- Logic High level:
Isolated: 4V ~30V
Non-Isolated TTL: 2V ~ 5V
- Logic Low level:
Isolated: 0 ~1V
Non-Isolated TTL: 0V~ 0.8V
- Isolation Voltage:2000V
- Built-in isolated power supply:5V,200mA max.
- Rising/Falling edge interrupt programmable
- LED indicator for each channel of digital input
- Power Consumption: 0.8W



I-8050 / I-8050-G (Gray color)

16-channel Universal Digital I/O Module

- Digital I/O channels: 16
- I/O Type: Selectable by programmed
- Digital Input: +2V(0); +4V~30V(1)
- Digital Output: Open-collector
Output: 100mA/channel
- Power consumption: 1W

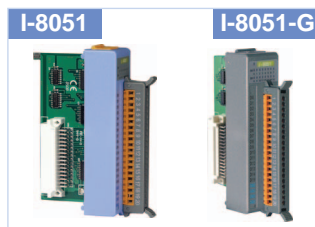

I-8051 / I-8051-G (Gray color)

16-channel Digital Input Module

- Digital Input channels: 16
- Digital Input level:
Logical level 0: +1V max.
Logical level 1: +3.5V~30V
- Power consumption: 0.8W

i-8000 Parallel I/O Modules

SERIES

8K Digital Modules

I-8052

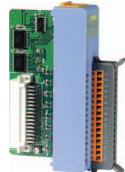

I-8052-G



I-8052 / I-8052-G (Gray color) 8-channel Isolated Digital Input Module

- Digital input channels: 8
- Differential input:
Logical level 0: +1V max.
Logical level 1: +3.5V~30V
- Isolation: 5000 Vrms.
- Power consumption: 0.8W

I-8053

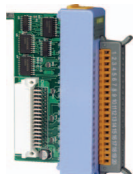

I-8053-G



I-8053 / I-8053-G (Gray color) 16-channel Isolated Digital Input Module

- Digital input channels: 16
- Single-ended input:
Logical level 0: +1V max.
Logical level 1: +3.5V~30V
Input resistance: 3K Ω , 1/4W
- Power consumption: 0.8W

I-8054



I-8054-G



I-8054 / I-8054-G (Gray color) 16-channel Isolated Digital I/O Module

- Digital input channels: 8
Logical level 0: +1V max.
Logical level 1: +3.5V~30V
- Digital output channels: 8
O.C. output: 375mA/channel, 30V
- Power consumption: 1W

I-8055



I-8055-G



I-8055 / I-8055-G (Gray color) 16-channel Digital I/O Module

- Digital input channels: 8
Logical level 0: +1V max.
Logical level 1: +3.5V~30V
- Digital output channels: 8
O.C. output: 125mA/channel
- Power consumption: 0.5W

8K Digital Modules

I-8056

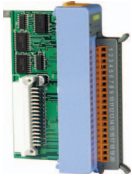

I-8056-G



I-8056 / I-8056-G (Gray color) 16-channel Non-isolated Open-collector Output Module

- Digital output channels: 16
O.C. output: 125mA/channel, 30V
- Power consumption: 0.7W

I-8057

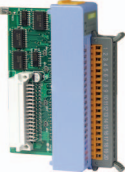

I-8057-G



I-8057 / I-8057-G (Gray color) 16-channel Isolated Open-collector Output Module

- Digital output channels: 16
O.C. output: 125mA/channel, 30V
- Isolation: 3750 Vrms
- Power consumption: 0.5W

I-8058

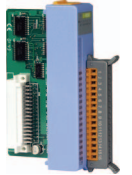

I-8058-G



I-8058 / I-8058-G (Gray color) 8-channel Isolated Digital Input Module

- Digital input channels: 8
- Input type: differential
- Input Voltage: Logical High: AC/DC 80V mini
Logical Low: AC/DC 30V max.
- Maximum Input voltage: AC/DC 250V
- Operating frequency: 1KHz(max.)
- Isolation: 3750 Vrms
- Power consumption: 0.8W

i-8000 Parallel I/O Modules

SERIES

8K Relay Module Selection Guide

Model	I-8060	I-8063	I-8064	I-8065	I-8066	I-8068	I-8069
Digital input Channels	—	4 isolation 3750V	—	—	—	—	—
Digital Output Channels	6 Form C	4 Form C	8 Channel Relay Form A AC 250V/5A DC 30V/5A	8 Channel SSR AC-type Relay Form A 24 to 265 Vrms@ 1.0Arms	8 Channel SSR DC-type Relay Form A DC: 3-30Vdc @1.0A	8 Channel Relay Form A x4 Form c x4	8 Photo Mos Relay Form A x8
LED Display	Yes	Yes	Yes	Yes	Yes	Yes	Yes
Safe Value	Yes	Yes	Yes	Yes	Yes	Yes	Yes
Power-on Preset Value	Yes	Yes	Yes	Yes	Yes	Yes	Yes
Dual Watchdog	—	—	—	—	—	—	—
Availability	Yes	Yes	Yes	Yes	Yes	Yes	Yes

8K Relay Modules

I-8060

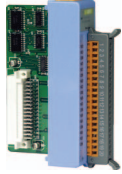

I-8060-G



I-8060 / I-8060-G (Gray color) 6-channel Relay Output Module

- Digital output channels: 6
- Form C relay
- Contact Rating:
AC: 125V @0.6A; 250V @0.3A
DC: 30V @2A; 110V @0.6A
- Power consumption: 2.2W

I-8063

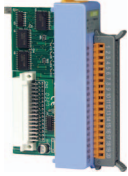

I-8063-G



I-8063 / I-8063-G (Gray color) 8-channel Isolated Digital I/O Module

- Digital input channels: 4
Differential Input
- Digital output channels: 4
Form C relay
AC: 125V @0.6A; 250V @0.3A
- Power consumption: 2W

I-8064



I-8064-G



I-8064 / I-8064-G (Gray color) 8-channel Power Relay Output Module

- Digital output channels: 8
- Form A relay
- Contact Rating: AC: 250V @5A
DC: 30V @5A
- Power consumption: 2.2W

I-8065



I-8065-G



I-8065 / I-8065-G (Gray color) 8-channel SSR-AC Output Module

- Digital output channels: 8
- Form A SSR
- Contact Rating: AC: 24~265Vrms @1.0Arms
Max. load current: 1.0Arms
- Power consumption: 0.8W

i-8000 Parallel I/O Modules

SERIES

8K Relay Modules

I-8066

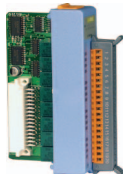

I-8066-G



I-8066 / I-8066-G (Gray color) 8-channel SSR-DC Output Module

- Digital output channels: 8
- Form A SSR
- Contact Rating: DC: 3~30 Vdc @1.0A
Max. load current: 1.0A
- Power consumption: 0.8W

I-8068



I-8068-G



I-8068 / I-8068-G (Gray color) 8-channel Relay Output Module

- Digital output channels: 8
Form C x4; Form A x4
- Contact Rating: AC: 120V @0.5A
DC: 30V @1A
- Power consumption: 2.4W

I-8069

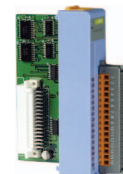

I-8069-G



I-8069 / I-8069-G (Gray color) 8-channel Photo Mos Relay Output Module

- Digital output channels: 8
- Form A Photo Mos relay
- Photo Mos Relay
- Load voltage: 350V (Peak AC)
- Continuous load current: 0.13A
- Power consumption: 0.5W

8K Memory Modules

I-8072



I-8072-G



I-8072 / I-8072-G (Gray color)

Printer Port & Xsocket Card

- Support Printer port
- Support two Xsocket
- Power Consumption: 0.3W

I-8073



I-8073-G



I-8073 / I-8073-G (Gray color)

MultiMediaCard(MMC) module

- MultiMediaCard socket : 1
- Digital input Channels :4
Logical level 0 : +1V max.
Logical level 1 : +3.5V~30V
- Digital output channels : 4
Open-collector output :100mA/30V max
- Analog Input Channel : 1
Input Range : +/-5V and 0~5V
- Power Consumption: 1W

I-8074W-G



Available soon

I-8074W-G (Gray color)

Memory module

- SRAM size : 128 ~ 1M Bytes
- Battery backup : Yes
- Battery monitor.
- Status LED:4 (Low Battery and Bad Battery)
- Power consumption: 1 W

8K Digital Input/Output Simulator Modules

I-8077

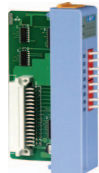

I-8077-G



I-8077 / I-8077-G (Gray color)

16-channel Digital I/O Simulator Module

- Digital Input Channels:8
- Input type : Toggle switch
- Output LED:8
- Power Consumption: 0.3W

i-8000 Parallel I/O Modules

SERIES

8K Counter/Frequency Modules

I-8080

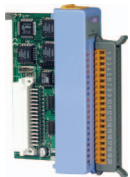

I-8080-G



I-8080 / I-8080-G (Gray color)

8-channel SSR-DC Output Module

- Digital output channels: 8
- Form A SSR
- Contact Rating:
 - DC: 3~30 Vdc @ 1.0A
 - Max. load current: 1.0A
- Power consumption: 0.8W

I-8081W-G



NEW!!

I-8081W-G (Gray color)

8-channel Counter/Frequency Module

- Counter channels: 8-ch up or 4-ch up/down
- Input frequency: 450k Hz max.
- Accuracy of frequency: 0.3 %
- Input type: TTL or Isolation.
- Programmable TTL input level.
- Programmable digital filter.

I-8082W-G



NEW!!

I-8082W-G (Gray color)

8-channel Frequency Module

- Counter channels: 8-ch
- Input frequency: 100k Hz max.
- Accuracy of frequency: 0.05 %
- Input type: TTL or Isolation.
- Programmable TTL input level.

8K Motion Modules

I-8090



I-8090-G



I-8090 / I-8090-G (Gray color)

3-axis Encoder Input Module

- Channels: 3
- Encoder type: single-ended or differential
- Logical level: TTL and COMS compatible
- Accept inputs from incremental or quadrature encoders
- Maximum quadrature input frequency: 1MHz
- Encoder input modes: Quadrature, Up/Down, Pulse/Direction
- Power Consumption: 3.4W

I-8091



I-8091-G



I-8091 / I-8091-G (Gray color)

2-axis Stepper/Servo Module

- Stepper channels: 2
- Step rate: 1pps~250Kpps
- Max. step count: +/-2
- Acceleration/Deceleration: Automatic trapezoidal acceleration/deceleration
- Output pulse signal: Two pulse (CW/CCW) mode or one pulse (Pulse, Direction) mode
- Output polarity: Positive/Negative programmable
- Power Consumption: 3.9W

I-8093-G



NEW!!

I-8093-G (Gray color)

3-axis Encoder Input Module

- Channels: 3-axis
- Encoder type: single-ended or differential
- Logical level: TTL and COMS compatible
- Accept inputs from incremental or quadrature encoders
- Maximum quadrature input frequency: 5MHz
- Encoder input modes: Quadrature, Up/Down, Pulse/Direction

i-8000 Parallel I/O Modules

SERIES

8K Analog Input/Output Modules

I-8017H

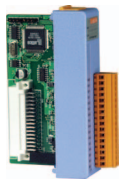

I-8017H-G



I-8017H / I-8017H-G (Gray color)

8-channel Isolated Analog Input Module

- Analog Input Channels: 8
- Resolution: 14-bit
- Input Type: Differential
- Input Range : $\pm 10V$, $\pm 5V$, $\pm 2.5V$, $\pm 1.25V$, $\pm 20mA$ (need 125Ω external resistor)
- Isolation Voltage: 3000Vdc
- Power Consumption: 2W
- Sampling rate:
 - Single Channel Polling Mode : 100Ksps
 - Single Channel Interrupt Mode : 50Ksps
 - 8 Channels Scan Mode : 16Ksps
- Input Bandwidth : 100KHz @ -3dB
- Input impedance: 200K Ω

I-8017HS-G



NEW!!

I-8017HS-G (Gray color)

8/16 Channel Isolated Analog Input Module

- Analog Input Channels: 8/16
- Resolution: 14-bit
- Input Type: Differential/Single End
- Input Range: $\pm 10V$, $\pm 5V$, $\pm 2.5V$, $\pm 1.25V$, $\pm 20mA$ (need 125Ω external resistor)
- Isolation Voltage: 3000Vdc
- Power Consumption: 2W
- Sampling Rate:
 - Single Channel Polling Mode: 100Ksps
 - Single Channel Interrupt Mode: 50Ksps
 - Multi Channel Scan Mode: 16Ksps
- Input Bandwidth: 100KHz @ -3dB
- Input Impedance: 200K Ω

I-8024



I-8024-G



I-8024 / I-8024-G (Gray color)

4-channel Isolated Analog Output Module

- Analog output channels: 4
- Voltage output: $\pm 10V$
- Current output: 0~20mA/4~20mA
- Isolation: 3000V
- Power Consumption: 2.2W

i-8000 Parallel Communication Modules

SERIES

8K RS-232/RS-422/RS-485 Modules

I-8112



I-8112-G



I-8112:

2-channel RS-232 Module

- RS-232 channels: 2
- Modem control
- TXD, RXD, RTS, CTS, DSR, DTR, DCD, RI, GND
- Transmission speed: 115.2K bps
- Shared Interrupt

I-8114



I-8114-G



I-8114:

4-channel RS-232 Module

- RS-232 channels: 4
- Modem control
- TXD, RXD, RTS, CTS, DSR, DTR, DCD, RI, GND
- Transmission speed: 115.2K bps
- Shared Interrupt

I-8142



I-8142-G



I-8142:

2-channel RS-422/485 Module

- RS-422/485 channels: 2
- Self-tuner chip inside
- TXD+, TXD-, RXD+, RXD-, RTS+, RTS-, CTS+, CTS-, GND
- Transmission speed: 115.2K bps
- Shared Interrupt

I-8142i



I-8142i-G



I-8142i:

2-channel isolated RS-422/485 Module

- RS-422/485 channels: 2
- Self-tuner chip inside
- TXD+, TXD-, RXD+, RXD-, RTS+, RTS-, CTS+, CTS-, GND
- Transmission speed: 115.2K bps
- Shared Interrupt
- Isolation: 3000V

I-8144



I-8144-G



I-8144:

4-channel RS-422/485 Module

- RS-422/485 channels: 4
- Self-tuner chip inside
- TXD+, TXD-, RXD+, RXD-, RTS+, RTS-, CTS+, CTS-, GND
- Transmission speed: 115.2K bps
- Shared Interrupt

i-87K Serial Modules

SERIES

87K Digital I/O Modules Selection Guide

Module		I-87040	I-87041	I-87051	I-87052	I-87053
Digital Input Channels		32 Isolation	–	16	8 differential Isolation (5000V)	16 Isolation (3750V)
Digital Output Channels		–	32 (open collector Isolation)	–	–	–
Counter	Channels	32	–	16	8	16
	Input Frequency	100Hz	–	100Hz	100Hz	100Hz
Safe Value		–	Yes	–	–	–
Power-on Preset Value		–	Yes	–	–	–
Dual Watchdog Timer		Yes	Yes	Yes	Yes	Yes
Availability		Y	Y	Y	Y	Y

Module		I-87054	I-87055	I-87057	I-87058
Digital Input Channels		8 Isolation (3750V)	8	–	8 differential Isolation (5000V)
Digital Output Channels		8 (open collector) Isolation (3750V)	8 (open collector) Isolation (3750V)	16 (open collector) Isolation (3750V)	–
Counter	Channels	8	8	–	8
	Input Frequency	100Hz	100Hz	–	100Hz
Safe Value		Yes	Yes	Yes	–
Power-on Preset Value		Yes	Yes	Yes	–
Dual Watchdog Timer		Yes	Yes	Yes	Yes
Availability		Y	Y	Y	Y

87K Relay Modules Selection Guide

Module		I-87063	I-87064	I-87065	I-87066	I-87068	I-87069
Digital Input Channels		4 Isolation (3750V)		–	–	–	–
Digital Output Channels		4 Channel Relay Form C x 4	8 Channel Relay Form A AC 250V/5A DC 30V/5A	8 Channel SSR AC-type Relay Form A 24 to 265 Vrms@1.0Arms	8 Channel SSR DC-type Relay Form A DC: 3-30VDC @1.0A	8 Channel Relay Form A x 4 Form C x 4	8 Channel PhotoMos Relay Form A x 8
Counter	Channels	4	–	–	–	–	–
	Input Frequency	100Hz	–	–	–	–	–
Safe Value		Yes	Yes	Yes	Yes	Yes	Yes
Power-on Preset Value		Yes	Yes	Yes	Yes	Yes	Yes
Dual Watchdog Timer		Yes	Yes	Yes	Yes	Yes	Yes
Availability		Y	Y	Y	Y	Y	Y

i-87K Serial Modules

SERIES

87K Digital Modules

I-87040



I-87040-G



I-87040 / I-87040-G (Gray color)

32-channel Digital Input Module

- Digital input channels: 32
- 3750V isolation (External power)
- Digital input level:
 - On state: +3.5V~30V
 - Off state: +1V max.
- Power Consumption: 1W

I-87041



I-87041-G



I-87041 / I-87041-G (Gray color)

32-channel Digital Output Module

- Digital Output channels: 32
- Open-collector Output: 100 mA/ channel
- Load Voltage : 5VDC to 30VDC
- Isolation Voltage : 3750Vrms
- Power consumption: 1W

I-87051



I-87051-G



I-87051 / I-87051-G (Gray color)

16-channel Digital Input Module

- Digital input channels: 16
- Digital input level:
 - On state: +1V max.
 - Off state: +3.5V~30V
- Power Consumption: 0.4W

87K Digital Modules

I-87052

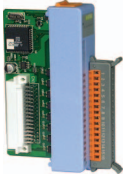

I-87052-G



I-87052 / I-87052-G (Gray color)

8-channel Isolated Digital Input Module

- Digital input channels: 8
- Differential input
 - On state: +3.5V~30V
 - Off state: +1V max.
- Isolation: 5000 Vrms
- Power Consumption: 0.3W

I-87053

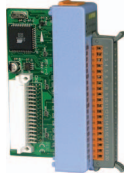

I-87053-G



I-87053 / I-87053-G (Gray color)

16-channel Isolated Digital Input Module

- Digital input channels: 16
- Single-ended input
 - On state: +3.5V~30V
 - Off state: +1V max.
- Isolation: 3750 Vrms
- Power Consumption: 0.3W

I-87054

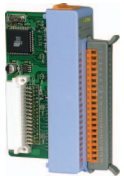

I-87054-G



I-87054 / I-87054-G (Gray color)

16-channel Isolated Digital I/O Module

- Digital input channels: 8
 - On state: +3.5V~30V
 - Off state: +1V max.
- Digital output channels: 8
 - O.C. output: 375mA/channel, 30V
- Power Consumption: 0.3W

i-87K Serial Modules

SERIES

87K Digital Modules

I-87055

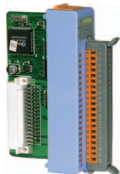

I-87055-G



I-87055 / I-87055-G (Gray color)

16-channel Digital I/O Module

- Digital input channels: 8
On state: +1V max.
Off state: +3.5V~30V
- Digital output channels: 8
O.C. output: 100mA/channel
- Power Consumption: 0.5W

I-87057



I-87057-G



I-87057 / I-87057-G (Gray color)

16-channel Isolated Open Collector Output Module

- Digital output channels: 16
O.C. output: 100mA/channel, 30V
- Isolation: 3750 Vrms
- Power Consumption: 0.3W

I-87058



I-87058-G



I-87058 / I-87058-G (Gray color)

8-channel Isolated Digital Input Module

- Digital input channel : 8 differential
- Input Voltage
Logical High : AC/DC 80V min.
Logical Low : AC/DC 30V max.
- Maximum Input Voltage :AC/DC 250V
- AC frequency : 45Hz(min.)
- Isolation :5000Vrms
- Power Consumption: 0.3W

87K Relay Modules

I-87063



I-87063-G



I-87063 / I-87063-G (Gray color)

8-channel Isolated Digital I/O Module

- Digital input channels: 4
Differential Input
- Digital output channels: 4
Form C
AC: 0.6A @125Vac, 2A @30Vdc
- Power Consumption: 0.3W

87K Digital Modules

I-87064



I-87064-G



I-87065

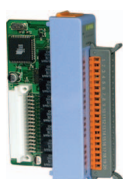

I-87065-G



I-87066



I-87066-G



I-87068



I-87068-G



I-87069



I-87069-G



I-87064 / I-87064-G (Gray color)
8-channel Power Relay Output Module

I-87065 / I-87065-G (Gray color)
8-channel SSR-AC Output Module

I-87066 / I-87066-G (Gray color)
8-channel SSR-DC Output Module

- Digital Output channels: 8
- Form A (Normal open)
- Contact Rating:

I-87064 – AC:250V @5A DC:30V @5A
 Power Consumption: 2.4W

I-87065 – AC: 24~265Vrms @1.0 Arms;
 leakage current:1.5mA Arms max.
 Power Consumption: 1W

I-87066 – DC: 3~30VDC @1.0A
 leakage current:0.1mA max.
 Power Consumption: 1W

I-87068 / I-87068-G (Gray color)
8-channel Relay Output Module

- Digital output channels: 8
- Form C x 4; Form A x 4
- Contact Rating: AC: 120VAC @0.5A
 DC: 30VDC @1A
- Power Consumption: 2.4W

I-87069 / I-87069-G (Gray color)
8-channel Relay Output Module

- Digital output channels: 8
- Form A Photo Mos relay
- Photo Mos Relay
- Load voltage: 350V (Peak AC)
- Continuous load current: 0.13A
- Power Consumption: 0.5W

i-87K Serial Modules

SERIES

87K Analog Input Module Selection Guide

Module		I-87005W	I-87013	I-87015	I-87016W	I-87017	I-87017R
Analog Input	Resolution	16 bit	16 bit	16 bit	16 bit	16/12 bit	16/12 bit
	Input channel	8 diff.	4 diff.	7 diff.	2 diff.	8 diff.	8 diff.
	Sampling rate	8 Hz (total)	10 Hz (total)	7 Hz (total)	10 Hz	10/60 Hz (total)	10/60 Hz (total)
	Voltage input	–	–	–	+/-15mV +/-50mV +/-100mV +/-500mV +/-1V +/-2.5V	+/-150mV +/-500mV +/-1V +/-5V +/-10V	+/-150mV +/-500mV +/-1V +/-5V +/-10V
	Current input	–	–	–	+/-20mA	+/-20mA	+/-20mA
	Sensor input	Thermistor (2-wire)	RTD Pt/Ni-RTD	RTD Pt/Ni/ Cu-RTD	–	–	–
	Input Linear scaling	–	–	–	Yes	–	–
Digital Output Channels	8 (open collector)	–	–	–	–	–	
Open Wire Detection	Yes	Yes	Yes	–	–	–	
Isolation Voltage	3000V	3000V	3000V	3000V	3000V	3000V	
Voltage Overload Protection	–	–	–	+/-35V	+/-35V	240Vrms	
Dual Watchdog Timer	Yes	Yes	Yes	Yes	Yes	Yes	
Availability	Note 1	Yes	Yes	Note 1	Yes	Yes	
Note 1: Will be available							

87K Analog Input Module Selection Guide

Module		I-87017RC	I-87017ML	I-87018	I-87018R	I-87019R
Analog Input	Resolution	16/12 bit	16/12 bit	16 bit	16 bit	16 bit
	Input channel	8 diff.	8 diff.	8 diff.	8 diff.	8 diff.
	Sampling rate	10/60 Hz (total)	10/60 Hz (total)	10 Hz (total)	10 Hz (total)	8 Hz (total)
	Voltage input	–	+/-150V +/-50V	+/-15mV +/-50mV +/-100mV +/-500mV +/-1V +/-2.5V	+/-15mV +/-50mV +/-100mV +/-500mV +/-1V +/-2.5V	+/-15mV +/-50mV +/-100mV +/-150mV +/-500mV +/-1V +/-2.5V +/-5V +/-10V
	Current input	+/-20mA 4-20mA 0-20mA	–	+/-20mA	+/-20mA	+/-20mA
	Sensor input	–	–	J.K.T.E.R.S.B. N.C.L.M.L2 thermocouple	J.K.T.E.R.S.B. N.C.L.M.L2 thermocouple	J.K.T.E.R.S.B. N.C.L.M.L2 thermocouple
	Input Linear scaling	–	–	–	–	–
Digital Output Channels		–	–	–	–	–
Open Wire Detection		–	–	–	Yes	Yes
Isolation Voltage		3000V	3000V	3000V	3000V	3000V
Voltage Overload Protection		+/-35V	+/-200V	+/-35V	240Vrms	+/-240Vrms
Dual Watchdog Timer		Yes	Yes	Yes	Yes	Yes
Availability		Yes	Yes	Yes	Yes	Yes

87K Analog Output Module Selection Guide

Module		I-87022	I-87024	I-87026
Analog Output	Resolution	12 bit	14 bit	16 bit
	Output channels	2 (Note 1)	4	2 (Note 1)
	Voltage output	0-10V	+/-10V, 0-10V, +/-5V, 0-5V	0-10V
	Current output	0-20mA 4-20mA	0-20mA 4-20mA	0-20mA 4-20mA
Safe Value		Yes	Yes	Yes
Power-on Preset Value		Yes	Yes	Yes
Dual Watchdog Timer		Yes	Yes	Yes
Availability		Yes	Yes	Yes

Note 1: Channel to Channel isolation

i-87K **Serial Modules**

SERIES

87K Analog Input Modules

I-87005W-G



Available soon

I-87005W-G (Gray color)

8-channel Thermistor Input and 8-channel Digital Output Module

- Analog Input Channels: 8
- Input Type: Precon ST-A3, Type u Fenwell, YSI, User-defined
- Accuracy: +/-0.1%
- Sampling Rate: 8 samples/second (Total)
- Common Mode Rejection: Typical 86dB
- Voltage Input Impedance: >1M Ohms
- Isolation Voltage: 3000VDC
- Individual Channel Configurable
- Wire Opening Detection
- Power Consumption: 1.2W
- Alarm Outputs: 8 (source)
- External Voltage: 10 ~ 40V
- Output Current: 650 mA per channel

I-87013

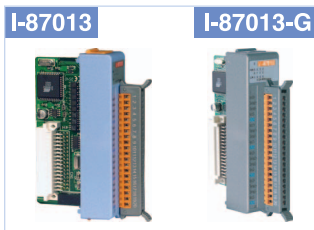

I-87013-G

I-87013 / I-87013-G (Gray color)

4-channel RTD Input Module

- Analog Input Channels: 4
- Input Type: 2/3/4 wire RTD
- Accuracy: +/-0.1%
- Sampling Rate: 10Hz (total)
- C.M.R.: 150dB @50.60Hz
- N.M.R.: 100dB @50/60Hz
- Isolation: 3000Vrms
- Power Consumption: 0.8W

I-87015-G



NEW!!

I-87015-G (Gray color)

7-channel RTD Input Module

- Analog Input Channels: 7
- Input Type: Pt100, Pt1000, Ni120, Cu100, Cu1000 supports 2/3 wire RTD
- Accuracy: +/-0.05%
- Sampling Rate: 10 samples/second (Total)
- Common Mode Rejection: Typical 86dB
- Voltage Input Impedance: >1M Ohms
- Isolation Voltage: 3000VDC
- Individual Channel Configurable
- Wire Opening Detection
- Power Consumption: 1.0W

87K Analog Input Modules

I-87016W-G



I-87016W-G (Gray color) 2-channel Isolated Strain Gauge Input Module

- Analog Input Channels: 2
- Isolation: 3000V
- Detail spec. call distributor

I-87017



I-87017-G

I-87017 / I-87017-G (Gray color) 8-channel Analog Input Module

- Analog Input Channels: 8 diff.
- Input Type: mV, V, mA (requires optional external 125 Ω resistor)
- Input Impedance: 20M
- Sampling Rate: 10Hz (total)
- Accuracy: +/-0.1%
- C.M.R.: 86dB
- Overvoltage Protection: -35~+35V
- Isolation: 3000Vrms
- Power Consumption: 1.1W

I-87017R-G



I-87017R-G (Gray color) 8-channel Analog Input Module with High Over Voltage Protection

- Analog Input Channels: 8 diff.
- Input Type: mV, V, mA (requires optional external 125 Ω resistor)
- Input Impedance: >1M Ohms
- Sampling Rate: 10Hz (Total)
- Accuracy: +/-0.1%
- C.M.R.: 86dB
- Overvoltage Protection: 240VRMS
- Isolation: 3000VDC
- Power Consumption: 1.2W

i-87K **Serial Modules**

SERIES

87K Analog Input Modules

I-87017RC-G



NEW!!

I-87017RC-G (Gray color)

8-channel Current Input Module

- Analog Input Channels: 8 diff.
- Input Type: +/-20mA, 0-20mA, 4-20mA (built-in 125Ω resistor)
- Sampling Rate:
Normal mode: 10Hz (total)
Fast mode: 60Hz (total)
- Accuracy:
Normal mode: +/-0.1%
Fast mode: +/-0.5%
- C.M.R.: 86dB
- Common Voltage: 200VDC
- Isolation: 3000VDC
- Power Consumption: 1.2W

I-87017ML-G



NEW!!

I-87017ML-G (Gray color)

8-channel High Voltage Input Module

- Analog Input Channels: 8 diff.
- Input Type: +/-50V, +/-150V
- Input Impedance: 290K Ohms
- Sampling Rate:
Normal mode: 10Hz (total)
Fast mode: 60Hz (total)
- Accuracy:
Normal mode: +/-0.1%
Fast mode: +/-0.5%
- C.M.R.: 86dB
- Overvoltage Protection: +/-200VDC
- Isolation: 3000VDC
- Power Consumption: 1.2W

I-87018



I-87018-G



I-87018 / I-87018-G (Gray color)

8-channel Analog Input Module

- Analog Input Channels: 8 diff.
- Input Type: mV, V, mA (requires optional external 125 Ω resistor), Thermocouple (J/K/T/E/R/S/B/N/C/L/M/L2)
- Input Impedance: 20MΩ
- Sampling Rate: 10Hz (total)
- Accuracy: +/-0.1%
- C.M.R.: 150dB @50/60Hz
N.M.R.: 100dB @50/60Hz
- Overvoltage Protection: -35~+35V
- Isolation: 3000Vrms
- Power Consumption: 1W

87K Analog Input Modules

I-87018R-G



I-87018R-G (Gray color)

8-channel Analog Input Module

- Analog Input Channels: 8 diff.
- Input Type: mV, V, mA (requires optional external 125Ω resistor), Thermocouple (J/K/T/E/R/S/B/N/C/L/M/L2)
- Input Impedance: >1M Ohms
- Sampling Rate: 10Hz (Total)
- Accuracy: +/-0.25%
- C.M.R.: 150dB @50/60Hz
- N.M.R.: 100dB @50/60Hz
- Overvoltage Protection: 240Vrms
- Isolation: 3000VDC
- Power Consumption: 1W

I-87019R-G



I-87019R-G (Gray color)

8-channel Universal Analog Input Module

- Input Type: mV, V, mA, Thermocouple
- Sampling Rate: 8 samples/second (Total)
- -3dB BandWidth: 15.7Hz
- Accuracy: +/-0.1%
- Common Mode Rejection: Typical 86dB
- Voltage Input Impedance: 1M Ohms
- Overvoltage Protection: 240Vrms
- Isolation Voltage: 3000VDC
- Individual Channel Configurable
- Wire Opening Detection
- Power Consumption: 1.1W

i-87K Serial Modules

SERIES

87K Analog Output Modules

I-87022



I-87022-G



I-87022 / I-87022-G (Gray color)

2-channel Isolated Analog Output Module

- Analog Output channels: 2
- Voltage Output: 0-10V
- Current Output: 0~20mA/4~20mA
- Resolution: 12 bits
- Power-on pre-set value
- Safe value
- Channel to channel isolation
- Power Consumption: 2.4W

I-87024

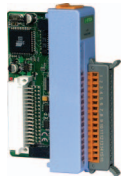

I-87024-G



I-87024 / I-87024-G (Gray color)

4-channel Isolated Analog Output Module

- Analog Output Channels: 4
- Voltage Output: +/-10V, +/-5V, 0~10V, 0~5V
- Current Output: 0~20mA/4~20mA
- Accuracy: +/-0.1% of FSR
- Resolution: +/-0.02% of FSR
- Span Temperature Co.: +/-20ppm/°C
- Isolation: 3000V
- Power Consumption: 1.7W

I-87026



I-87026-G



I-87026 / I-87026-G (Gray color)

2-channel Isolated Analog Output Module

- Analog Output channels: 2
- Voltage Output: 0-10V
- Current Output: 0~20mA/4~20mA
- Resolution: 16 bits
- Power-on pre-set value
- Safe Value
- Channel to Channel Isolation
- Power Consumption: 2.2W

87K Counter/Frequency Modules

I-87082



I-87082-G



I-87082 / I-87082-G (Gray color)

2-channel Counter/Frequency Module

- Counter Channels: 2
- Input Frequency: 100KHz (1Hz~100KHz)
- Power Consumption: 1W